

# Scheda Tecnica - Technical Sheet

# Vicky

400871W 400871W-B  
400871C 400871C-B  
400871D 400871D-B



## Proiettore a led per esterno



**30W**  
**2550Lm**  
**120°**

## Dati generali

*Product overview*

Nome prodotto/Product name	VICKY
Codice prodotto/Product code	400871
Materiale/Housing material	Alluminio
Colore/Colour	Bianco - Nero
Ambiente di utilizzo/Environment	Esterno
Certificazione/Certifications	CE
Lumen/Lumen	2550
Gradi Kelvin/Kelvin degrade (K)	3000K/4000K/6500K
Angolo/Beam angle	120°
Consumo/Power	30W
Tensione/Voltage	220-240V 50/60Hz
Classe sicurezza/Isolation class	I Classe
Classe protezione/Protection degree	IP 65
Classe energetica/Energy label	F
Dimensioni articolo/Carton product	14,3x13,0x2,4 (cm)
Dimensioni scatola singolo/Gift box	14,7x11,2x3,5 (cm)
Dimensioni cartone/Carton dimensions	Updating (cm)
Imballo/Packing	20

# Scheda Tecnica - Technical Sheet

# Vicky

400871W    400871W-B  
 400871C    400871C-B  
 400871D    400871D-B



## Packaging

Scatolo con stampa  
in quadricromia

Giftbox 4 colours

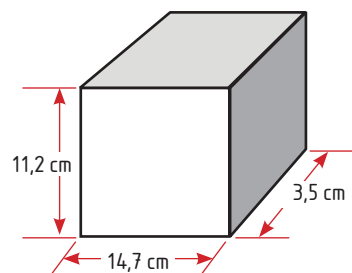

CONFEZIONE SINGOLA  
Giftbox

## Export carton

Bar code:  
Position 4 sides  
in the upper left

400871W		8 053329 481793
400871W-B		8 053329 481809
400871C		8 053329 481816
400871C-B		8 053329 481823
400871D		8 053329 482530
400871D-B		8 053329 482547

Lateral sides  
Shipping mark:

**Poliplast**

P/I NO.:  
 LOT NO.: 1518-24-22  
 CTN NO.:  
 MADE IN P.R.C.  
 ITEM NO.: 400871W-B

Central sides  
Shipping mark:

**Poliplast** 400871W-B

Importato da Poliplast srl  
 via Oliveto Scarmascia 27c  
 85 27 Calenzano (CT)  
 8 053329 481809  
 Made in P.R.C.  
 www.poliplast.com

VICKY 400871W-B 185-265V~ 50/60Hz 30W 3000K

QTY:	20	PCS
G.W.:		Kg
N.W.:		Kg
MEAS:		CM

VICKY 400871W-B

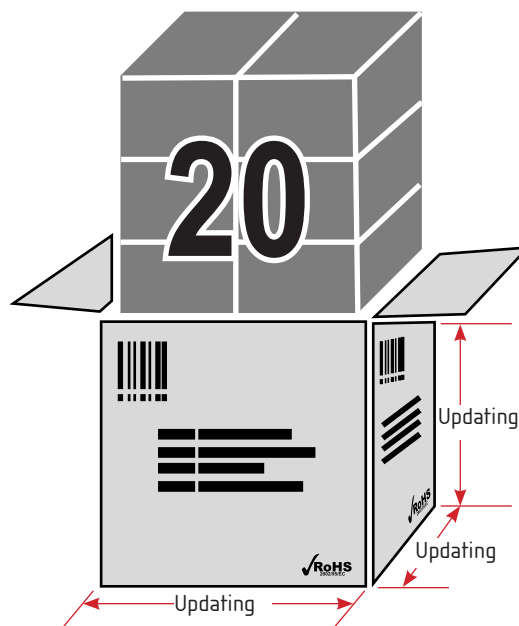

# Scheda Tecnica - Technical Sheet

# Vicky

400871W	400871W-B
400871C	400871C-B
400871D	400871D-B



## Dettagli Tecnici

**Dimensioni**  
Dimensions

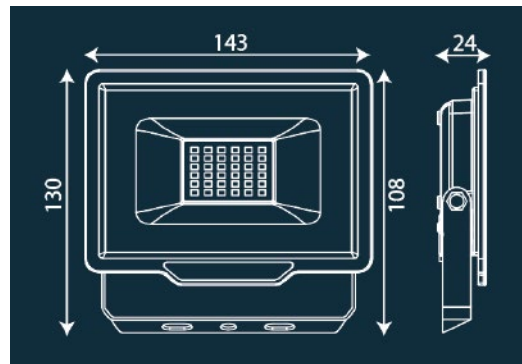

## Labels

**Targhetta specifiche tecniche**  
Technical label

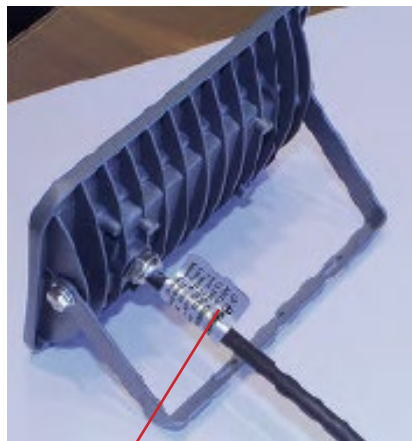

38x18 mm

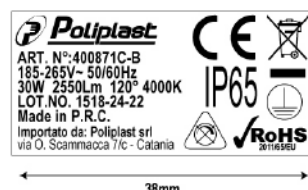
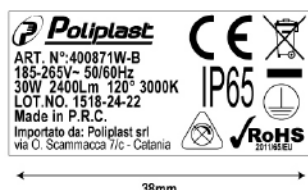
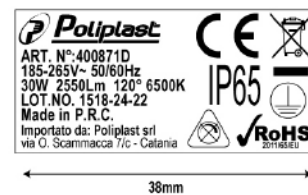
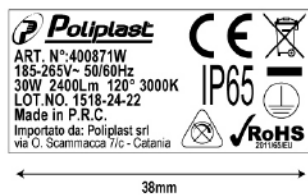

# Scheda Tecnica - Technical Sheet

# Vicky

400871W  
400871C  
400871D

400871W-B  
400871C-B  
400871D-B



## SCHEMA COLLEGAMENTI

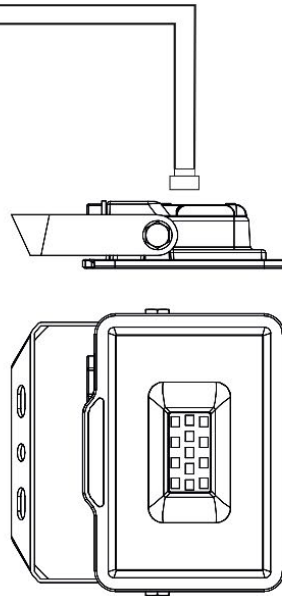

### Collegamenti elettrici

Cavo H05RN-F 3G1,0 mm<sup>2</sup>

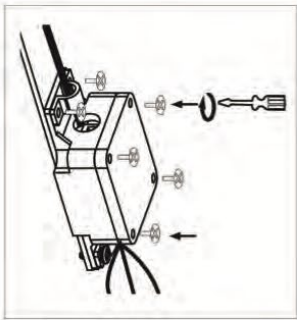
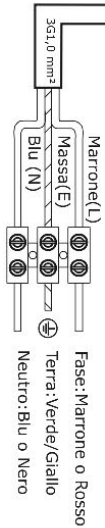

Utilizzare una scatola stagna per i collegamenti

## MANUALE DI ISTRUZIONE

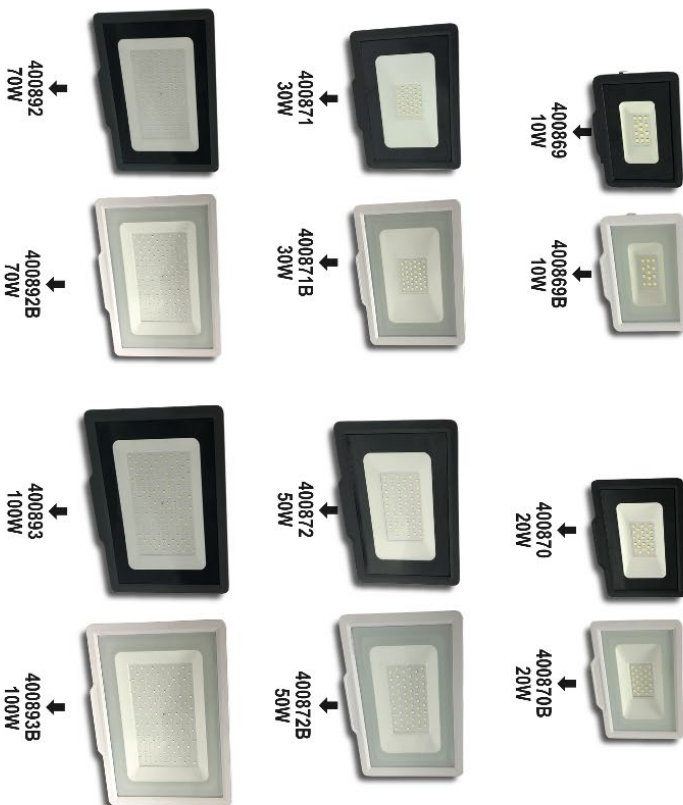

Poliplast srl  
Direzione e  
Uffici Amministrativi:

Via Oliveto Scammacca, 7/c Tal. +39 095 7357530 pbx  
95127 Catania (Italy)

www.poliplast.it  
info@poliplast.it



# Scheda Tecnica - Technical Sheet

# Vicky

400871W  
400871C  
400871D

400871W-B  
400871C-B  
400871D-B



## MANUALE DI ISTRUZIONE PROIETTORE A LED

Nota: leggere attentamente le istruzioni prima di installare l'articolo.  
IMPORTANTE: L'installazione o qualsiasi operazione di manutenzione devono essere eseguite a corrente elettrica disconnessa.

### INSTALLAZIONE:

- A**ssicurarsi che la corrente elettrica sia disconnessa.
- R**imuovere la staffa di montaggio per segnare il foro nella posizione desiderata.
- P**ratificare un foro della misura adeguata ad un tassello da muro e fissare la staffa.
- U**tilizzare una scatola stagna per i collegamenti e terminare il cablaggio.
- F**issare il proiettore con le viti.
- C**onnettere la corrente elettrica.

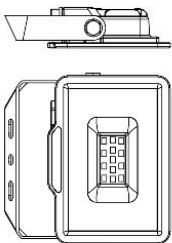

Rimuovere la staffa di montaggio

### AVVERTENZA DI SICUREZZA:

- P**rima dell'utilizzo leggere attentamente il manuale di istruzioni.
- A**ssicurarsi che il prodotto sia sufficientemente ventilato.
- N**on coprire l'apparecchio durante l'utilizzo.
- N**on installare la lampada alla portata di bambini o animali.
- I**l prodotto non deve essere manipolato al fine di usufruire della garanzia.
- L**a Poliplast srl non è responsabile in caso di mancato rispetto delle avvertenze di sicurezza.
- L'**installazione deve essere effettuata da personale tecnico.
- U**tilizzare un cavo per uso esterno e non inferiore a 105FRN-F 301,00 mm<sup>2</sup>, e realizzare i collegamenti tramite scatola stagna.
- L**a lampada non è dimmerabile.

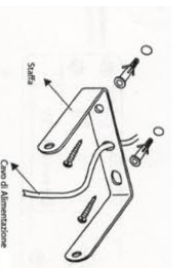

Fissare la staffa con i tasselli e inserire il cavo di alimentazione nel foro centrale

Tabella delle caratteristiche tecniche

Articolo	Luce	Colore	Watt	Lumen	Descrizione
400869.	3000K 4000K 6500K	Nero Bianco	10W	770Lm 800Lm 800Lm	185-265V 50/60Hz - 120° IP65 CLASSE I completo di 15 cm di cavo 3x1,00 mm <sup>2</sup>
400870.	3000K 4000K 6500K	Nero Bianco	20W	1550Lm 1600Lm 1600Lm	185-265V 50/60Hz - 120° IP65 CLASSE I completo di 15 cm di cavo 3x1,00 mm <sup>2</sup>
400871.	3000K 4000K 6500K	Nero Bianco	30W	2400Lm 2550Lm 2550Lm	185-265V 50/60Hz - 120° IP65 CLASSE I completo di 15 cm di cavo 3x1,00 mm <sup>2</sup>
400872.	3000K 4000K 6500K	Nero Bianco	50W	4100Lm 4250Lm 4250Lm	185-265V 50/60Hz - 120° IP65 CLASSE I completo di 15 cm di cavo 3x1,00 mm <sup>2</sup>
400892.	3000K 4000K 6500K	Nero Bianco	70W	6300Lm 6300Lm 6300Lm	185-265V 50/60Hz - 120° IP65 CLASSE I completo di 30 cm di cavo 3x1,00 mm <sup>2</sup>
400893.	3000K 4000K 6500K	Nero Bianco	100W	8300Lm 8500Lm 8500Lm	185-265V 50/60Hz - 120° IP65 CLASSE I completo di 30 cm di cavo 3x1,00 mm <sup>2</sup>

CODICE PRODOTTO	EAN	Questo prodotto contiene una sorgente luminosa di classe efficienza energetica:
400869W	8053329481717	F
400869C	8053329481731	F
400869D	8053329482493	F
400869W-B	8053329481724	F
400869C-B	8053329481748	F
400869D-B	8053329482509	F
400870W	8053329481755	F
400870C	8053329481779	F
400870D	8053329482516	F
400870W-B	8053329481762	F
400870C-B	8053329481786	F
400870D-B	8053329482523	F
400871W	8053329481793	F
400871C	8053329481816	F
400871D	8053329482530	F
400871W-B	8053329481809	F
400871C-B	8053329481823	F
400871D-B	8053329482547	F
400872W	8053329481830	F
400872C	8053329481854	F
400872D	8053329482554	F
400872W-B	8053329481847	F
400872C-B	8053329481861	F
400872D-B	8053329482561	F
400892W	8053329482592	F
400892C	8053329482615	F
400892D	8053329482578	F
400892W-B	8053329482608	F
400892C-B	8053329482622	F
400892D-B	8053329482585	F
400893W	8053329482646	F
400893C	8053329482660	F
400893D	8053329482684	F
400893W-B	8053329482639	F
400893C-B	8053329482653	F
400893D-B	8053329482677	F